

EE 230

Lecture 24

Waveform Generators

- Poles of Waveform Generators

Quiz: Determine the poles of the following circuit. Assume the op amp is ideal.

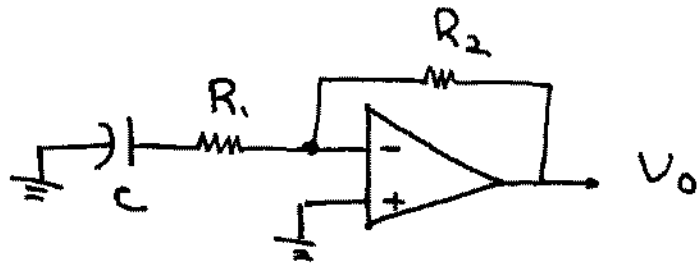

3

Solution:

Apply any excitation that does not change the dead network and determine any output.

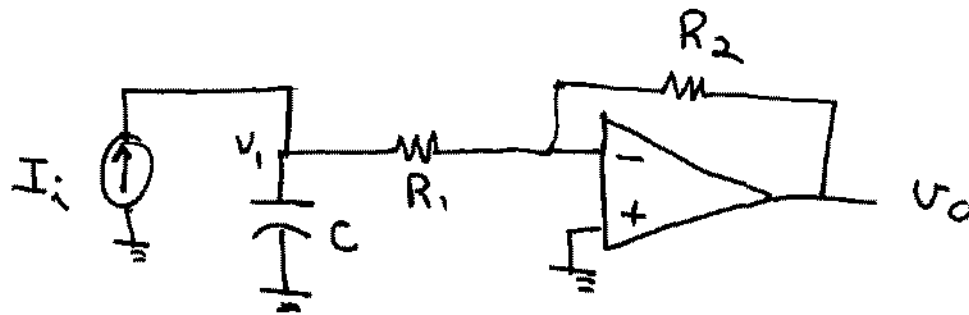

By KCL

$$\left. \begin{aligned} \frac{V_o}{R_2} + \frac{V_1}{R_1} &= 0 \\ V_1 sC + \frac{V_1}{R_1} &= I_i \end{aligned} \right\}$$

$$V_o = -\frac{R_2}{R_1} \left(\frac{I_i}{sC + 1/R_1} \right)$$

$$\frac{V_o}{I_i} = \frac{-R_2}{1 + sCR_1} \Rightarrow P = -\frac{1}{R_1 C}$$

Review from last time:

- Triangular waveform Generator Introduced

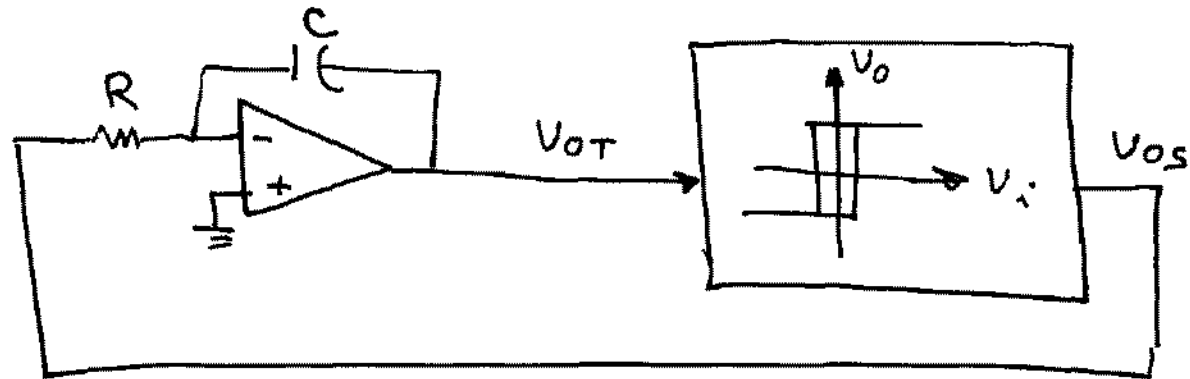

- triangle amplitude independent of f_{osc}
- simultaneous sinusoidal and triangular outputs
- Concept of "dead network" introduced
 - obtained by setting all independent sources to 0
- Theorem introduced about finding poles of a linear circuit

Theorem: The poles of any transfer function of a linear system are independent of where the excitation is applied and where the response is taken provided the dead networks are the same.

Observation:

Poles are an inherent and unique characteristic of any linear system

Poles of Waveform Generators

Consider the following waveform generator.

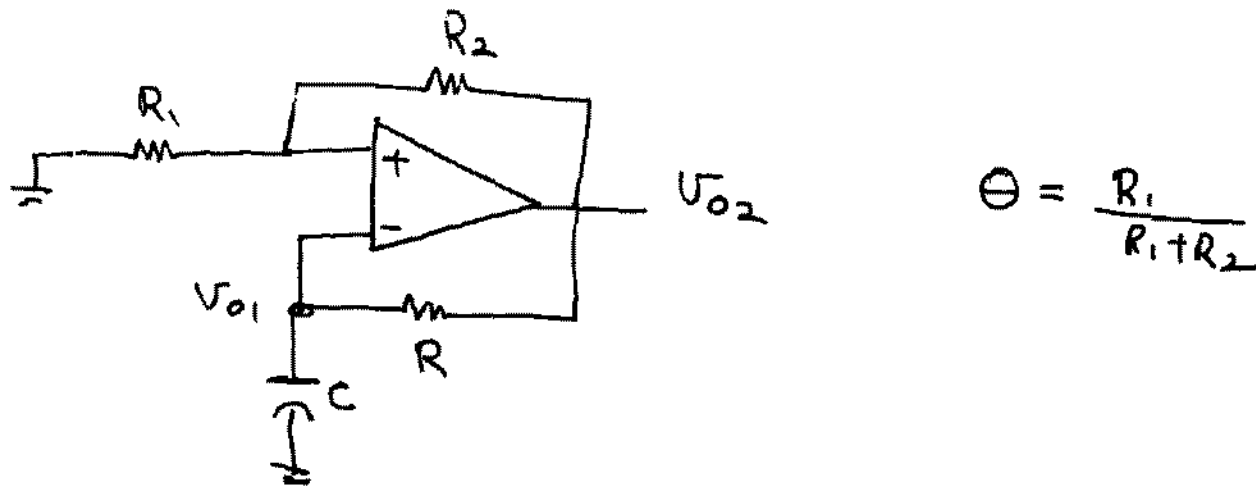

$$\Theta = \frac{R_1}{R_1 + R_2}$$

- Determine the poles of this circuit
- Issue: There is no excitation so transfer function is not defined

Strategies for determining poles of networks with no excitations:

1) • Apply any excitation that does not alter the dead network

• Obtain transfer function $T(s) = \frac{N(s)}{D(s)}$

• Poles are roots of $D(s)$

• By theorem, they are unique

(independent of where excitation is applied or response is taken)

2) Develop new strategy that does not require assigning excitation and reduces calculation requirements

Lets digress for a bit - to develop a second strategy for obtaining the poles of a network

Consider the following circuit

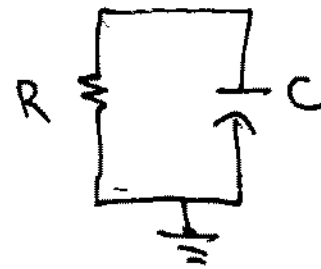

The following all have this as a dead network

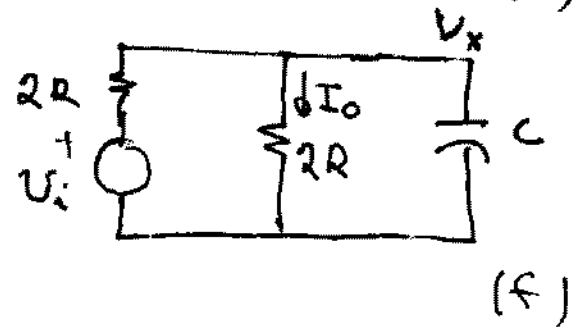
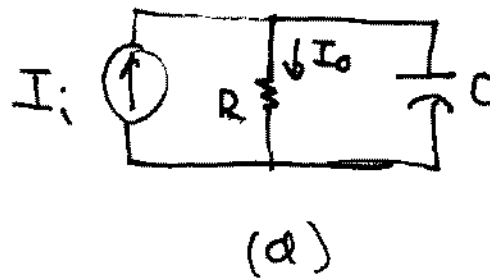
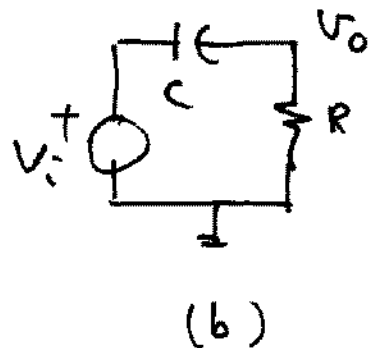
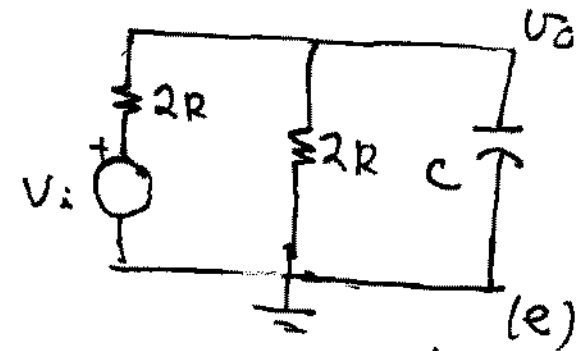
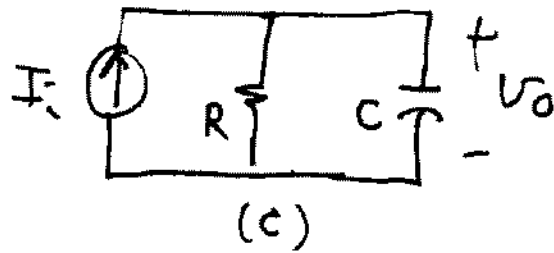
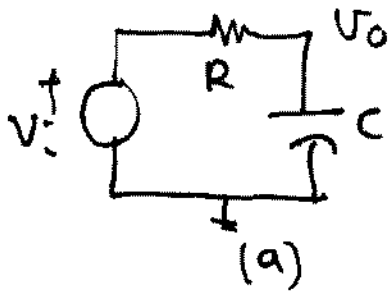

Analyzing (a)

$$\frac{V_o}{V_i} = \frac{1/s_c}{R + 1/s_c} = \frac{1}{1 + RCs}$$

Analyzing (b)

$$\frac{V_o}{V_i} = \frac{R}{R + 1/s_c} = \frac{RCs}{1 + RCs}$$

Analyzing (c)

$$V_o \left(s_c + \frac{1}{R} \right) = I_i$$

$$\therefore \frac{V_o}{I_i} = \frac{1}{s_c + 1/R} = \frac{R}{1 + RCs}$$

Analyzing (d)

$$\frac{I_o}{I_i} = \frac{1/s_c}{R + 1/s_c} = \frac{1}{1 + RCs}$$

Analyzing (e)

$$V_o \left(sC + \frac{1}{2R} + \frac{1}{2R} \right) = \frac{V_i}{2R}$$

$$\frac{V_o}{V_i} = \frac{\frac{1}{2R}}{sC + \frac{1}{R}} = \frac{\frac{1}{2}}{1 + RCs}$$

Analyzing (f)

$$V_x \left(sC + \frac{1}{2R} + \frac{1}{2R} \right) = \frac{V_i}{2R} \quad \left. \vphantom{\frac{V_i}{2R}} \right\}$$

$$V_x = I_o(2R)$$

$$\therefore \frac{I_o}{V_i} = \frac{\frac{1}{4R^2}}{sC + \frac{1}{R}} = \frac{\frac{1}{4}R}{RCs + 1}$$

- Observe all have the same denominator polynomial
- This was expected since all have the same dead network and since Theorem states all poles will be identical
- If only poles are of interest, considerable computational overhead of finding overall transfer function has been experienced
- The denominator polynomial of a transfer function is defined to be the characteristic polynomial of the circuit, often designated as $D(s)$
- In the previous example, $D(s) = 1 + RCs$

Consider the dead network

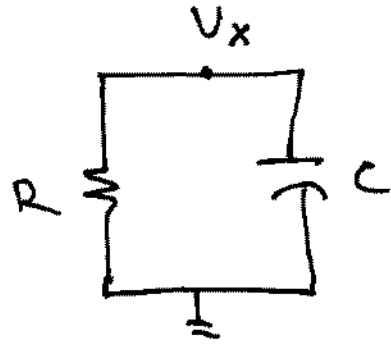

By KCL

$$V_x \left(sC + \frac{1}{R} \right) = 0$$

$$V_x (RCs + 1) = 0$$

Observe that even though no excitation was applied, the last equation is of the form

$$V_x D(s) = 0$$

This method for obtaining $D(s)$ is not just a coincidence applicable to this example but rather can be applied to an arbitrary linear network as stated in the following Theorem.

Theorem: The characteristic polynomial $D(s)$ of a system can be obtained by assigning an output variable to the "dead network" and using circuit analysis techniques to obtain an expression that involves only the output variable expressed in the form $X_0 F(s) = 0$. When expressed in this form, $F(s)$ when written in polynomial form is the characteristic polynomial of the system. i.e.

$$D(s) = F(s).$$

Example. Determine the characteristic polynomial for the following circuit

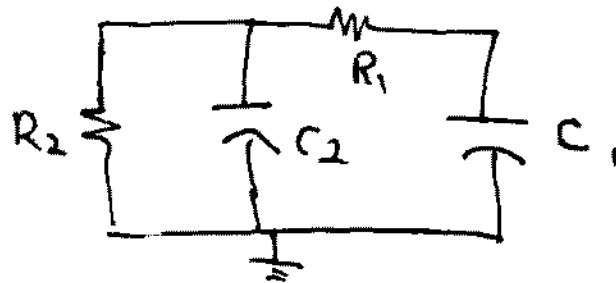

Solution: Assign V_0 to one of the nodes

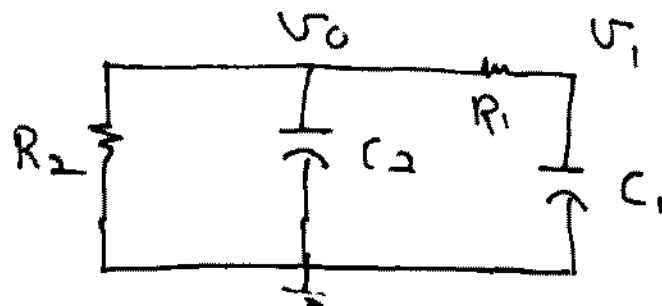

$$(G_1 = \frac{1}{R_1}, G_2 = \frac{1}{R_2})$$

By KCL

$$\left. \begin{aligned} V_0 (G_2 + G_1 + sC_2) &= V_1 G_1 \\ V_1 (G_1 + sC_1) &= V_0 G_1 \end{aligned} \right\}$$

Eliminating V_1 between these two equations we obtain

$$V_0 (G_1 + G_2 + sC_2) = G_1 V_0 \frac{G_1}{G_1 + sC_1}$$

or

$$V_0 (G_1^2 + G_1 G_2 + sC_2 G_1 + sC_1 G_2 + sC_1 G_1 + s^2 C_1 C_2 - G_1^2) = 0$$

or

$$V_0 (s^2 C_1 C_2 + s(C_1 [G_1 + G_2] + C_2 G_1) + G_1 G_2) = 0$$

or

$$V_0 \left(s^2 + s \left(\frac{[G_1 + G_2]}{C_2} + \frac{G_1}{C_1} \right) + \frac{G_1 G_2}{C_1 C_2} \right) = 0$$

The characteristic polynomial for this circuit is

$$D(s) = s^2 + s \left(\frac{[G_1 + G_2]}{C_2} + \frac{G_1}{C_1} \right) + \frac{G_1 G_2}{C_1 C_2}$$

Consider again the waveform generator. A resistor R_x has been added but if $R_x = \infty$ this becomes the waveform generator considered earlier

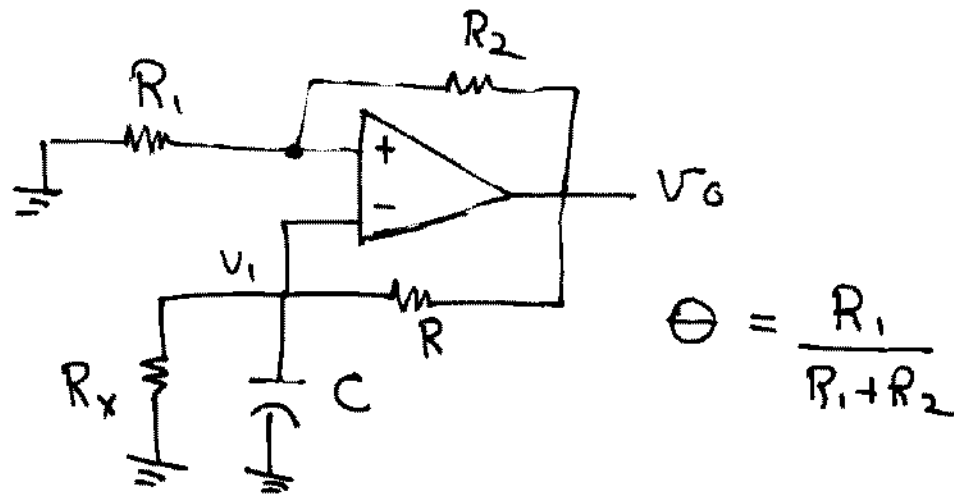

Obtain the poles of this circuit. Assume OA is ideal solving, we obtain

$$V_i = \Theta V_o$$

$$V_i \cdot \left(\frac{1}{R} + \frac{1}{R_x} + sC \right) = \frac{V_o}{R}$$

$$V_o \left(s + \left[\frac{1}{R_c} \frac{(\Theta - 1)}{\Theta} + \frac{1}{R_x C} \right] \right)$$

$$\therefore D(s) = s + \frac{1}{RC} \frac{(\theta - 1)}{\theta} + \frac{1}{R_x C}$$

If $R_x = \infty$, this circuit has a single pole at

$$p = \frac{1}{RC} \left(\frac{1 - \theta}{\theta} \right)$$

Since $0 < \theta < 1$, this circuit has a single pole on the positive real axis and is unstable

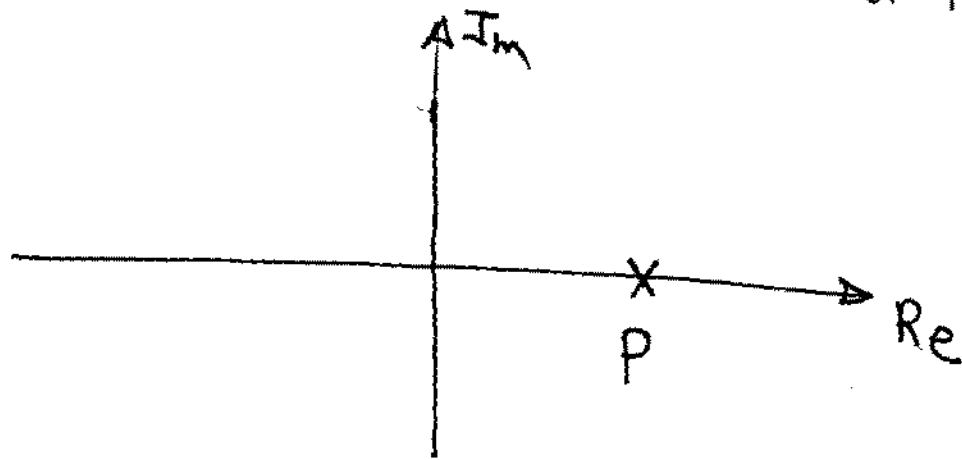

Determine the minimum value of R_x that will maintain instability in the previous circuit.

$$D(s) = s + \frac{1}{RC} \left(\frac{\theta - 1}{\theta} \right) + \frac{1}{R_x C}$$

\therefore pole at

$$p = \frac{1 - \theta}{\theta} \left(\frac{1}{RC} \right) - \frac{1}{R_x C}$$

Setting this equal to 0 (when it leaves RHP)

obtain

$$\frac{1}{C R_{x \min}} = \frac{1 - \theta}{\theta} \left(\frac{1}{RC} \right)$$

or

$$R_{x \min} = R \left(\frac{\theta}{1 - \theta} \right)$$

Where are the poles of the following waveform generator?

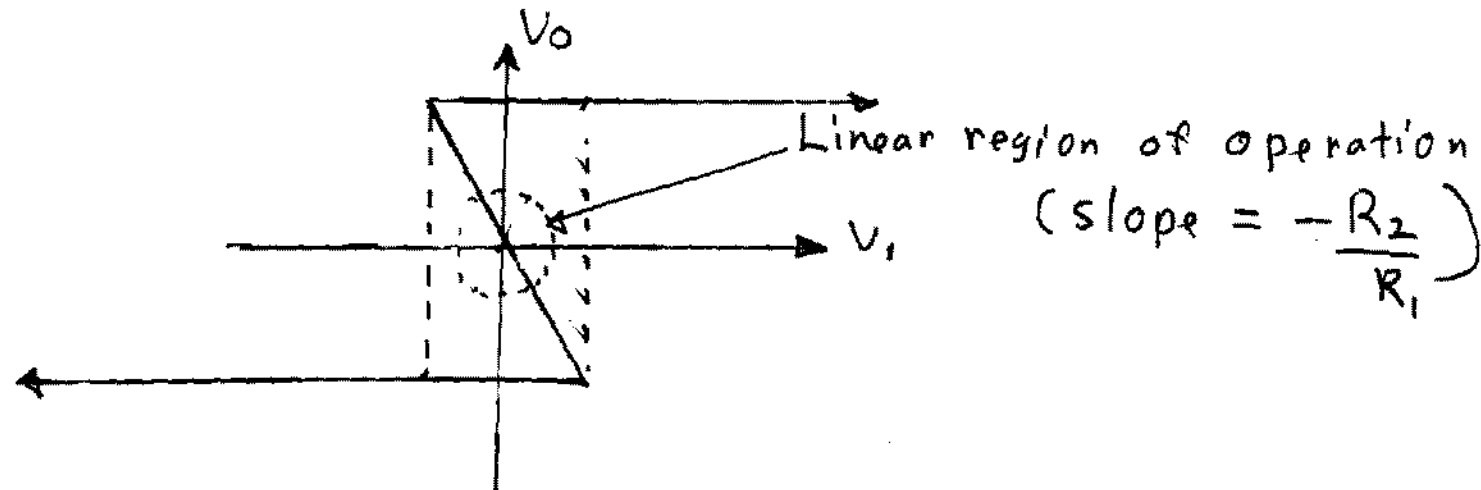
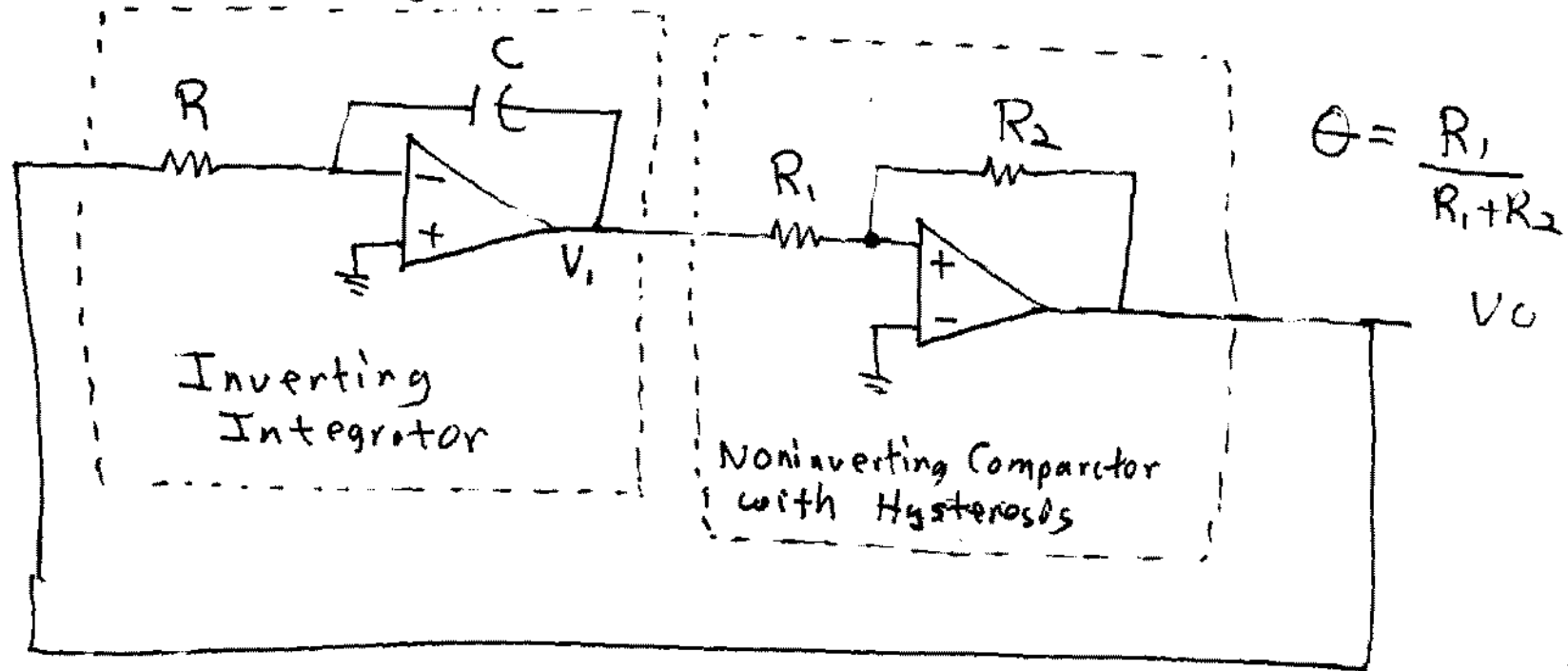

Transfer Characteristics of Comparator

Must use linear mode of operation to find poles of the circuit

$$\left. \begin{aligned} V_0 &= -\frac{R_2}{R_1} V_1 \\ V_1 &= -\frac{1}{RCs} V_0 \end{aligned} \right\} \text{ solving, obtain } V_0 \left(s - \frac{R_2}{R_1} \frac{1}{RC} \right) = 0$$

\therefore single pole at $p = \left(\frac{R_2}{R_1} \right) \frac{1}{RC}$

Note pole in RHP on positive real axis

